

Varenummer: 0125123  
 Beskrivelse: Seeger låsering SP150  
 Fjederstål

## Mål

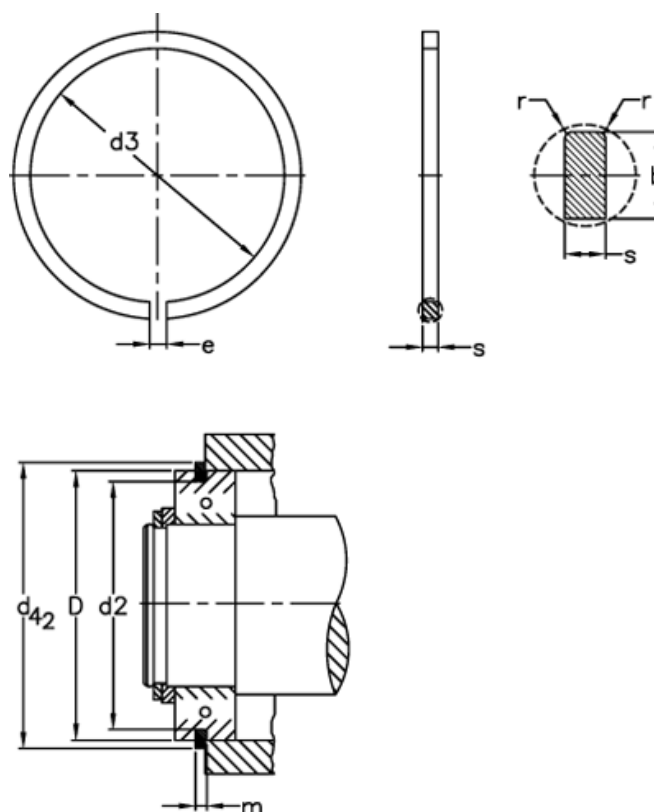

b	= 7.21	FRg kN	= 15.00	tol	= -0.15
Betegnelse	= SP 150	FR kN	= 101.5	tol	= -0.1
D	= 150	g	= 4.0	tol	= -0.50
d2	= 145.24	K kN-mm	= 234.0	tol	= 0.3
d3	= 142.9	m	= 3.10	tol	= 1.6
d42	= 159.7	n abl x 1000	= 1.0	vægt kg/1000	= 77.2
e	= 7	r min	= 0.7		
FN kN	= 193.0	s	= 2.82		